

SECTION A-A

DO NOT SCALE DRAWING

REV 1

This product may be covered by one or more patents or patent applications.  
See <http://www.standardlifters.com/patents.html> for details.

**GK1.50-N-Base Machining**

**Standard Lifters Inc**

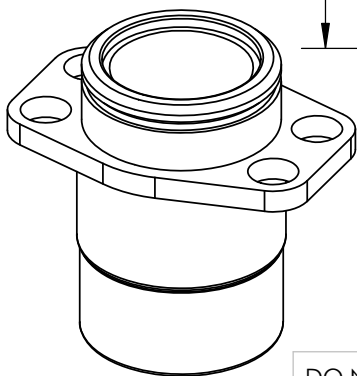
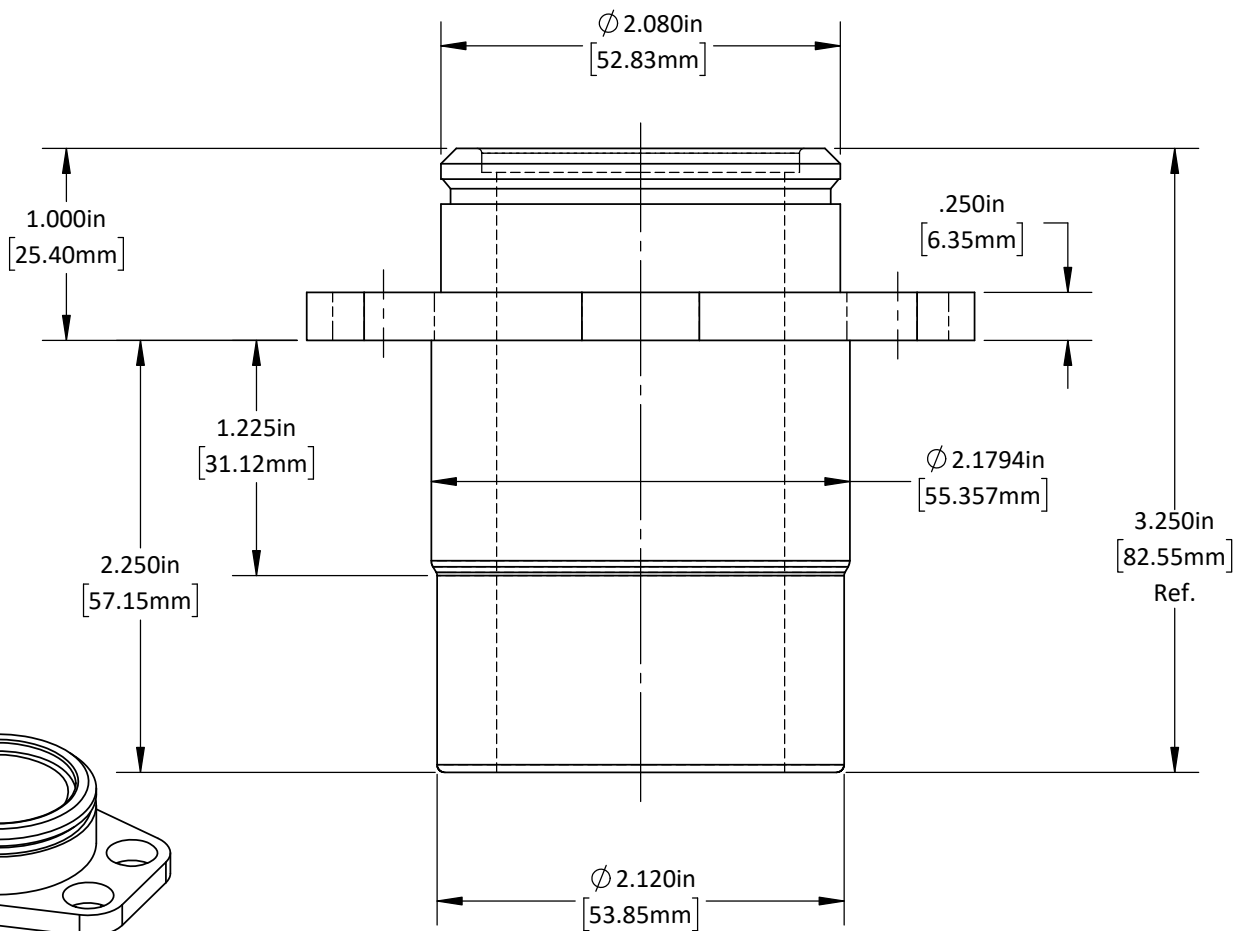
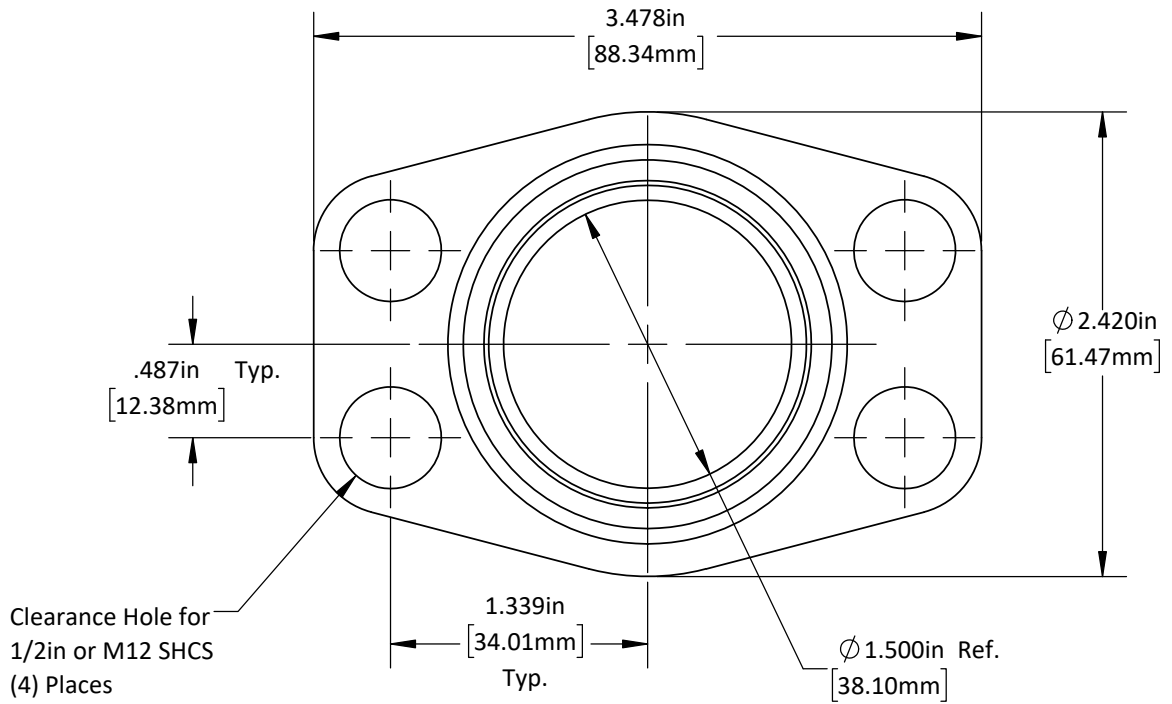

DO NOT SCALE DRAWING

REV 1

This product may be covered by one or more patents or patent applications. See <http://www.standardlifters.com/patents.html> for details.

**Base-GK1.50-N3-1**

**Standard Lifters Inc**