

SECTION A-A

DO NOT SCALE DRAWING	REV 1
This product may be covered by one or more patents or patent applications. See http://www.standardlifters.com/patents.html for details.	

GK1.25-N-Base Machining
Standard Lifters Inc

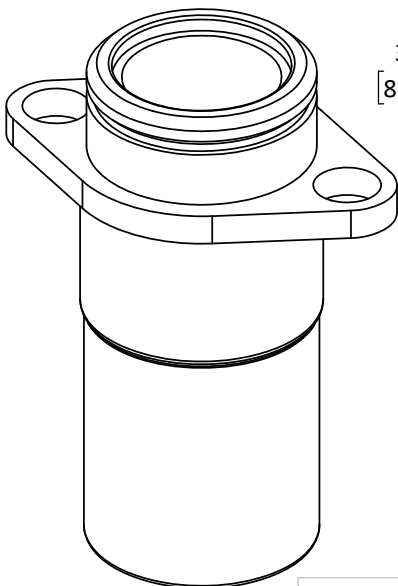
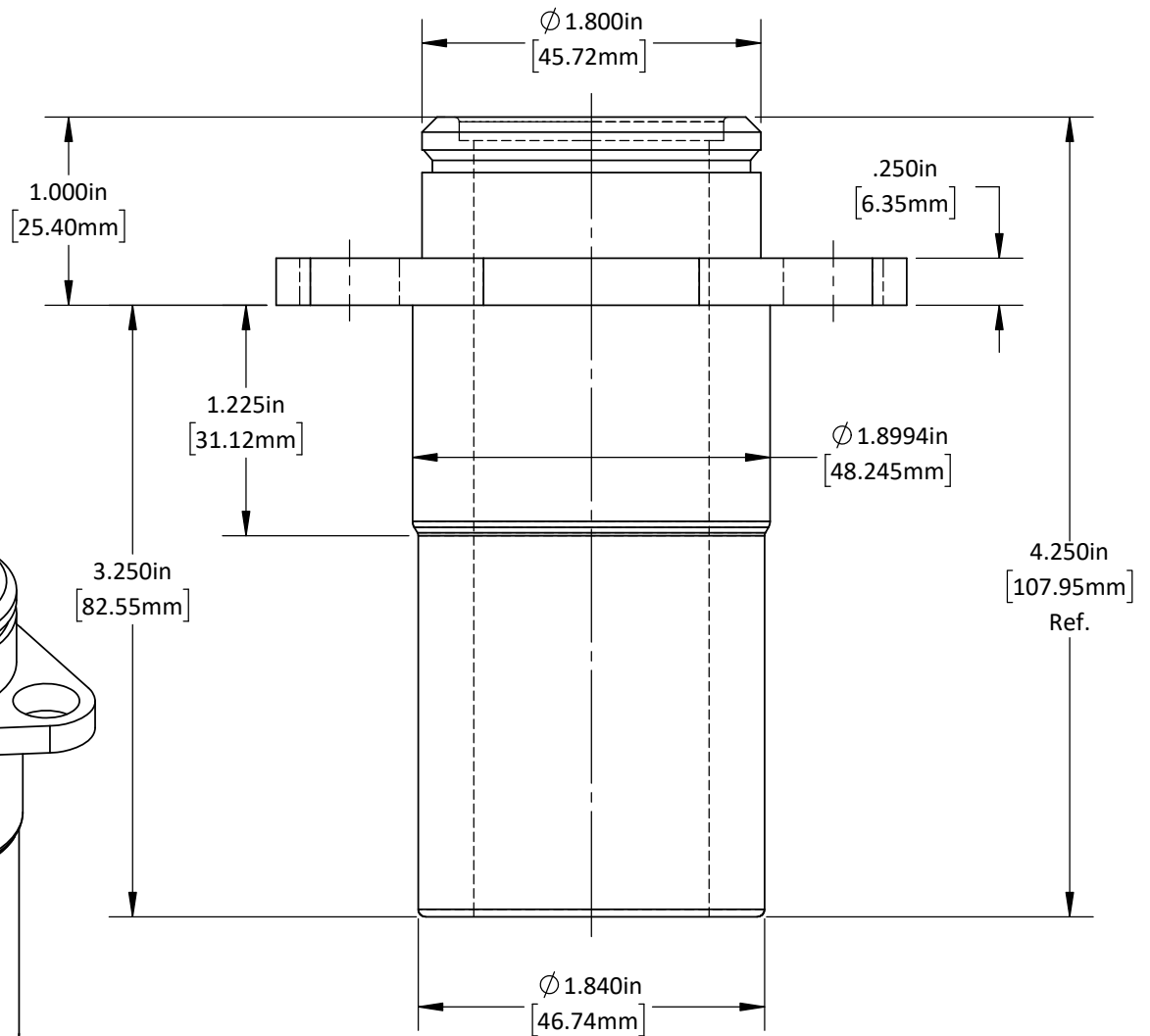
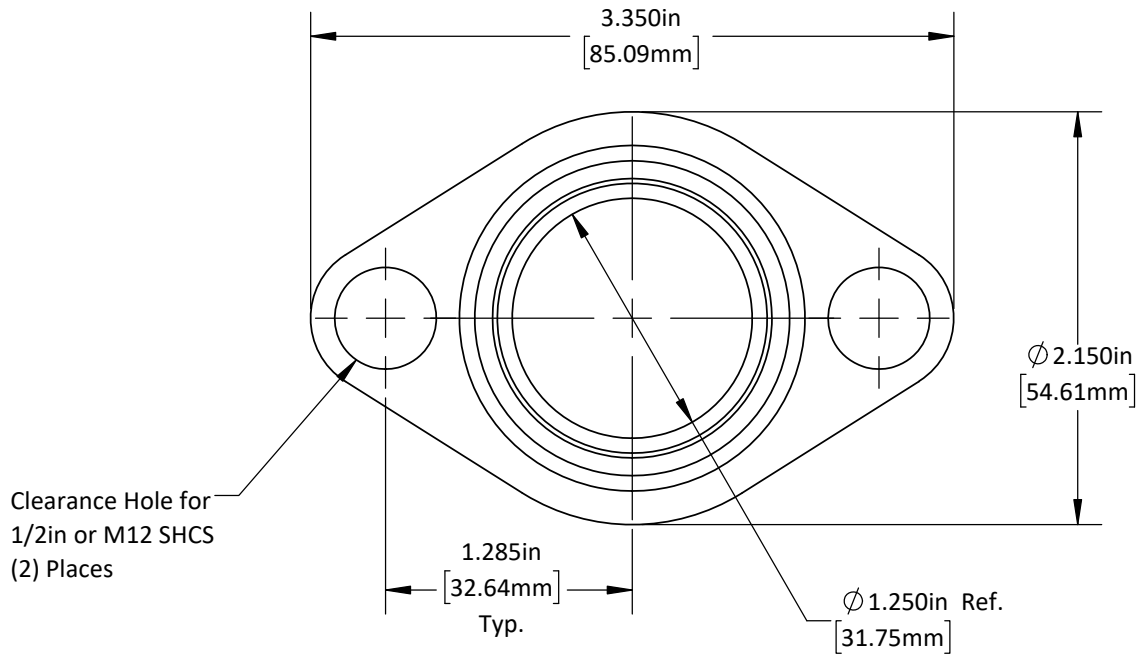

DO NOT SCALE DRAWING REV 1

This product may be covered by one or more patents or patent applications. See <http://www.standardlifters.com/patents.html> for details.

Base-GK1.25-N4-1

Standard Lifters Inc