

SECTION A-A

DO NOT SCALE DRAWING

REV 1

This product may be covered by one or more patents or patent applications.
See <http://www.standardlifters.com/patents.html> for details.

GK1.00-N-Base Machining

Standard Lifters Inc

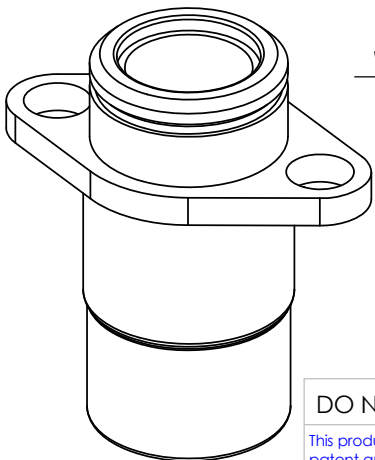
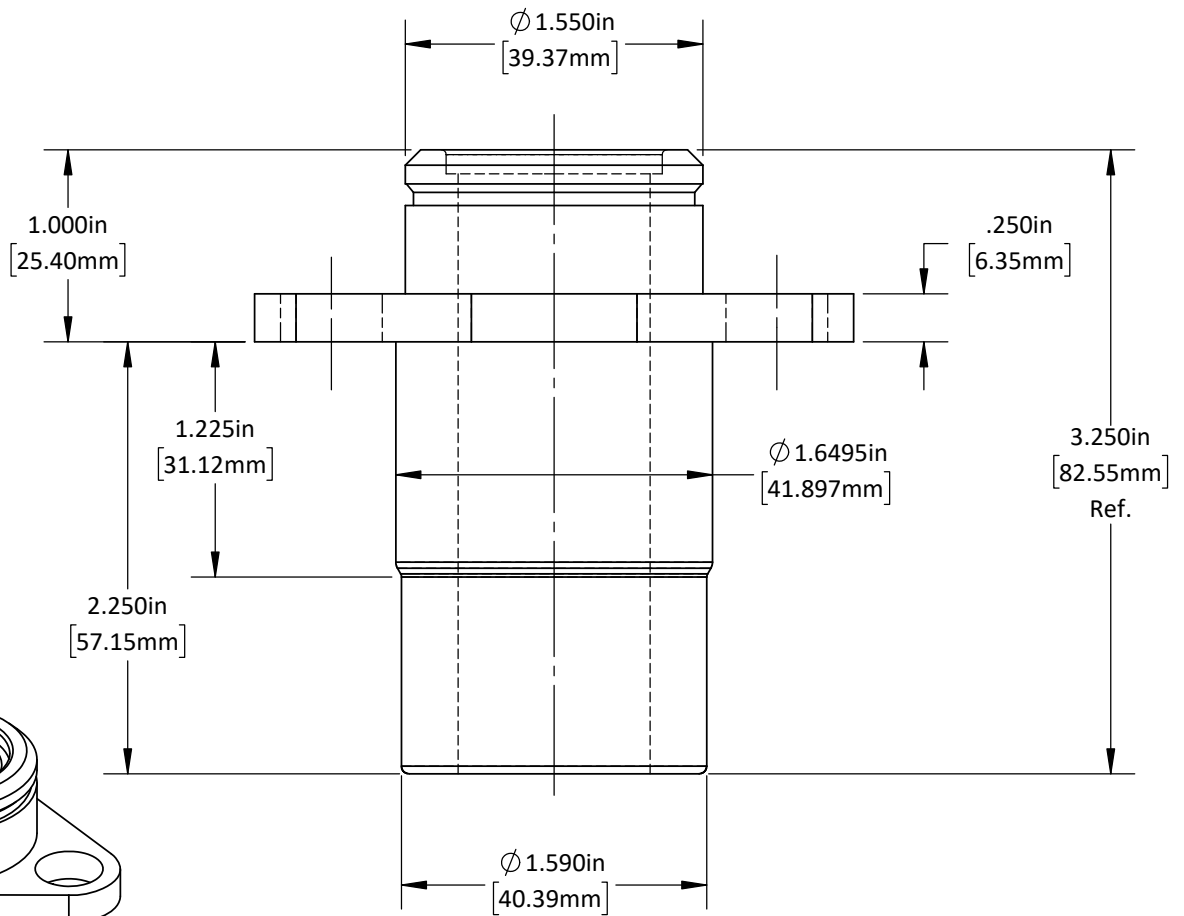
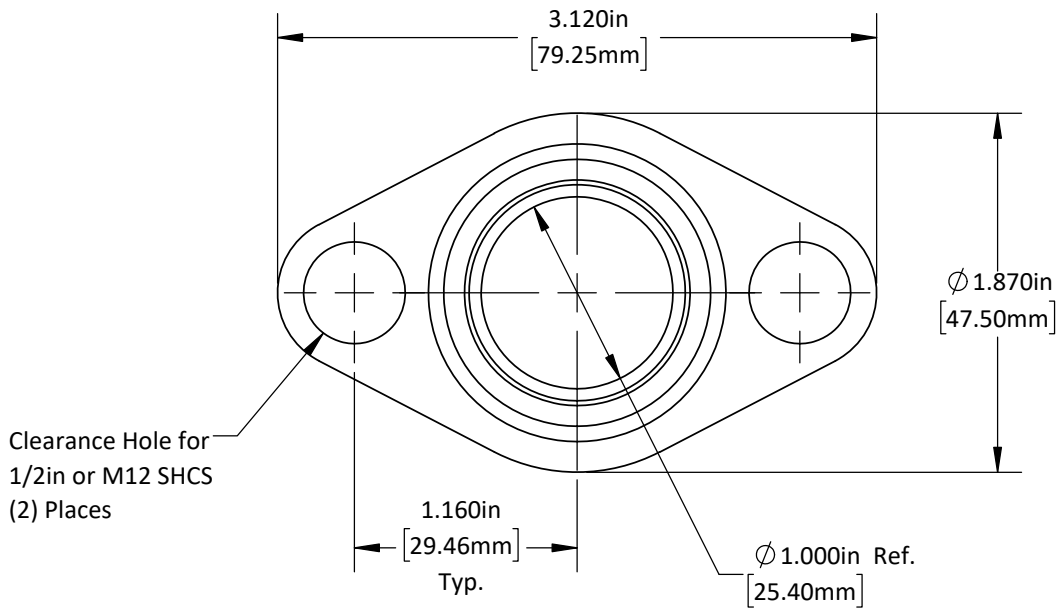

DO NOT SCALE DRAWING

REV 1

This product may be covered by one or more patents or patent applications. See <http://www.standardlifters.com/patents.html> for details.

Base-GK1.00-N3-1

Standard Lifters Inc