

SECTION A-A

DO NOT SCALE DRAWING

REV 3

This product may be covered by one or more patents or patent applications.
 See <http://www.standardlifters.com/patents.html> for details.

Pilot-PA-.625-.125-S-P-W-Machining

STANDARD LIFTERS INC

$\varnothing .094\text{in}$ [2.4mm] Ejector Pin
 (6) Equally Spaced on a
 $\varnothing .780\text{in}$ [19.81mm] Bolt Circle

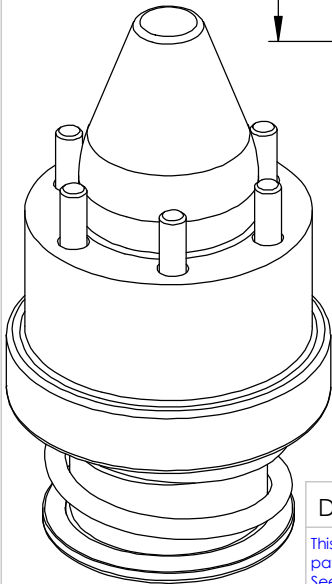
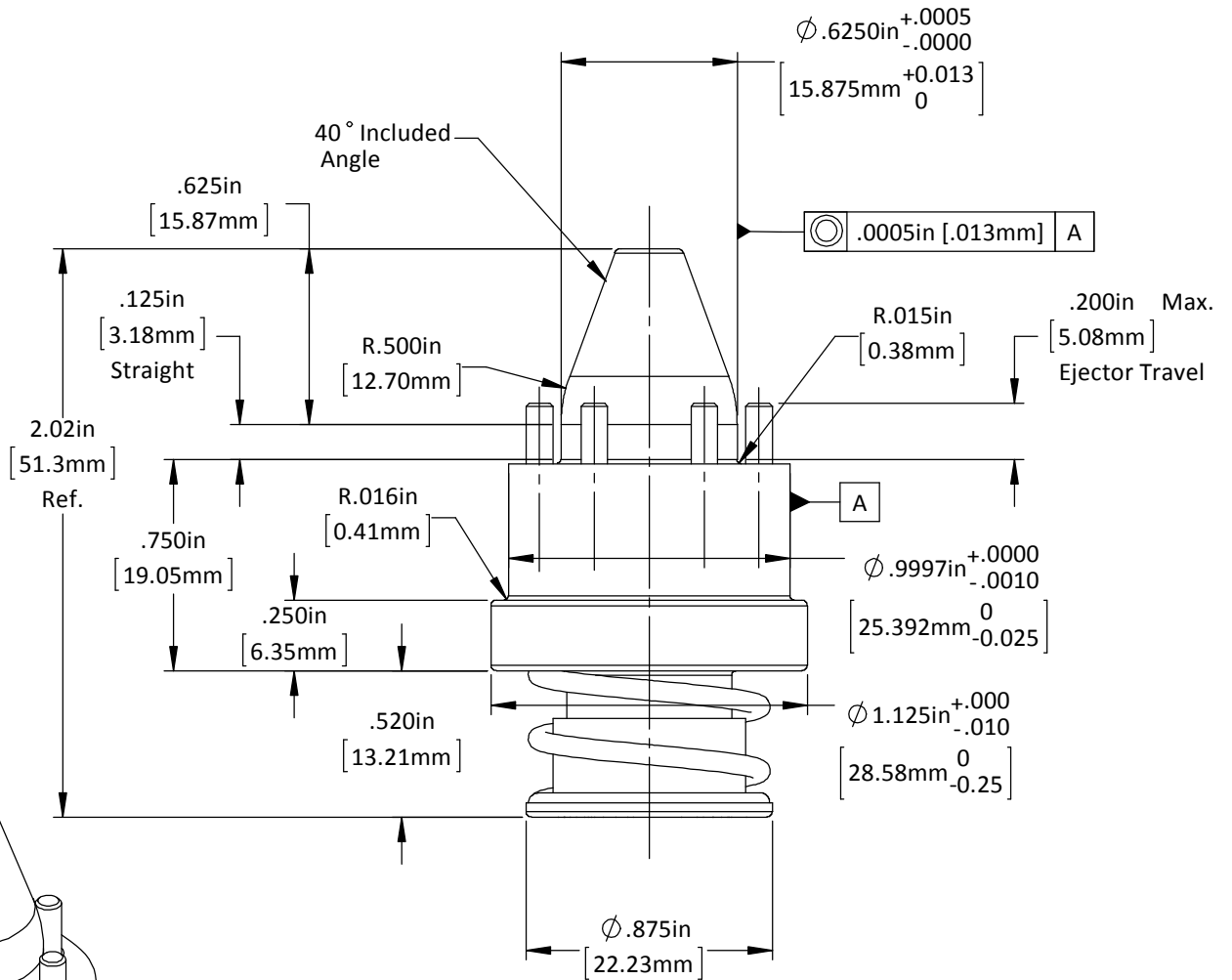
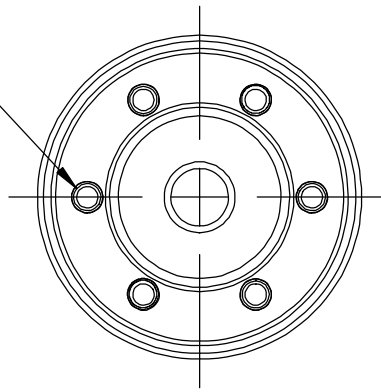

DO NOT SCALE DRAWING REV 2

This product may be covered by one or more patents or patent applications.
 See <http://www.standardlifters.com/patents.html> for details.

Pilot-PA-.625-.125-S-P-W

STANDARD LIFTERS INC