

*Recommended Minimum Hole Size to be
Cylinder Body Diameter +1mm [.04"]

"E" = 3/8"-16 Tap X .75in Dp.
"M" = M10-1.50 Tap X 20mm Dp.

DO NOT SCALE DRAWING	REV 1
This product may be covered by one or more patents or patent applications. See http://www.standardlifters.com/patents.html for details.	

Gas Spring Clamp-GSC-32-B-Machining
STANDARD LIFTERS INC

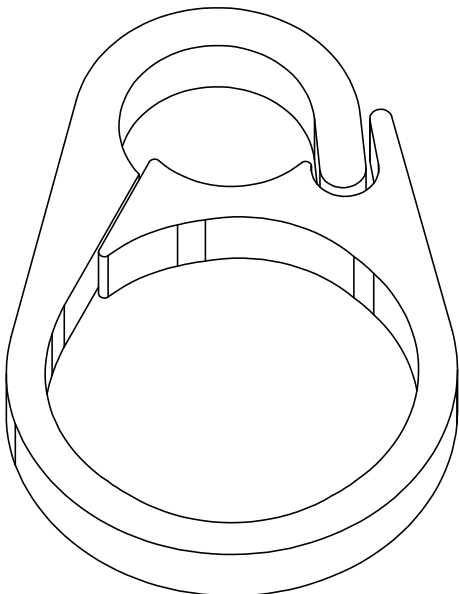
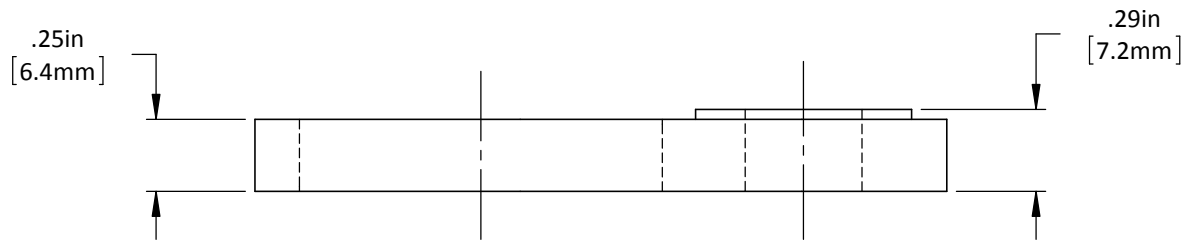
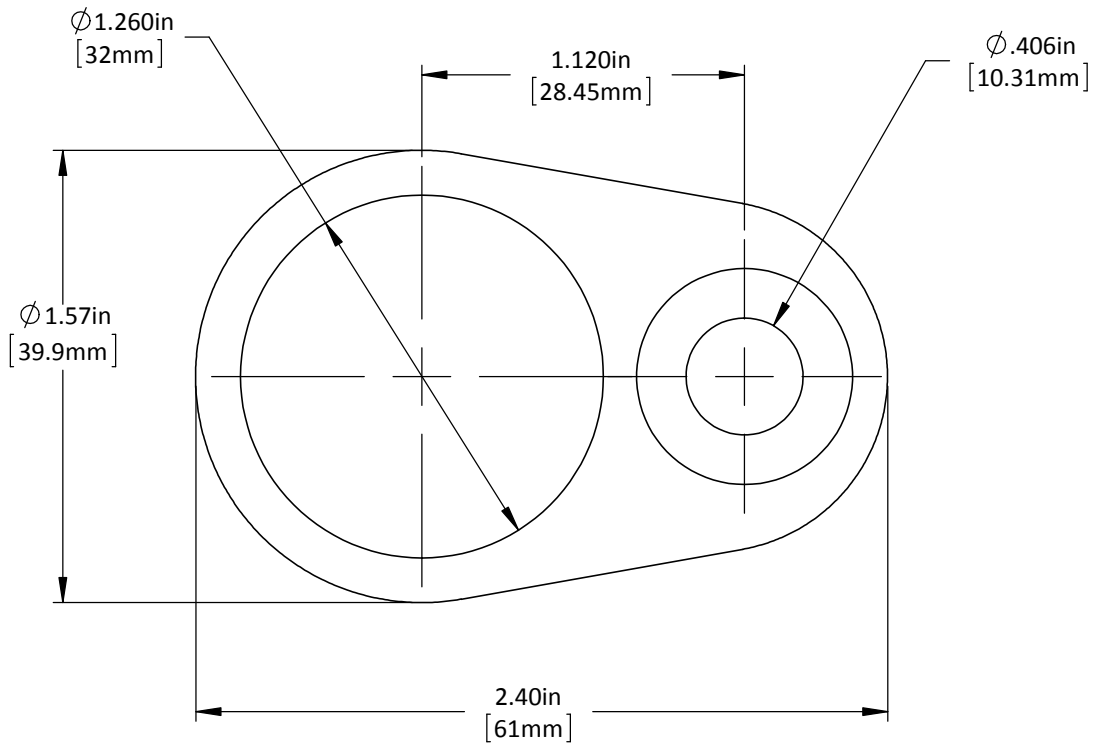

DO NOT SCALE DRAWING | REV 1

This product may be covered by one or more patents or patent applications.
 See <http://www.standardlifters.com/patents.html> for details.

Gas Spring Clamp-GSC-32-B

STANDARD LIFTERS INC