

DO NOT SCALE DRAWING REV 1

This product may be covered by one or more patents or patent applications.
See <http://www.standardlifters.com/patents.html> for details.

Pilot-PA-.375-.050-S-R-F

STANDARD LIFTERS INC

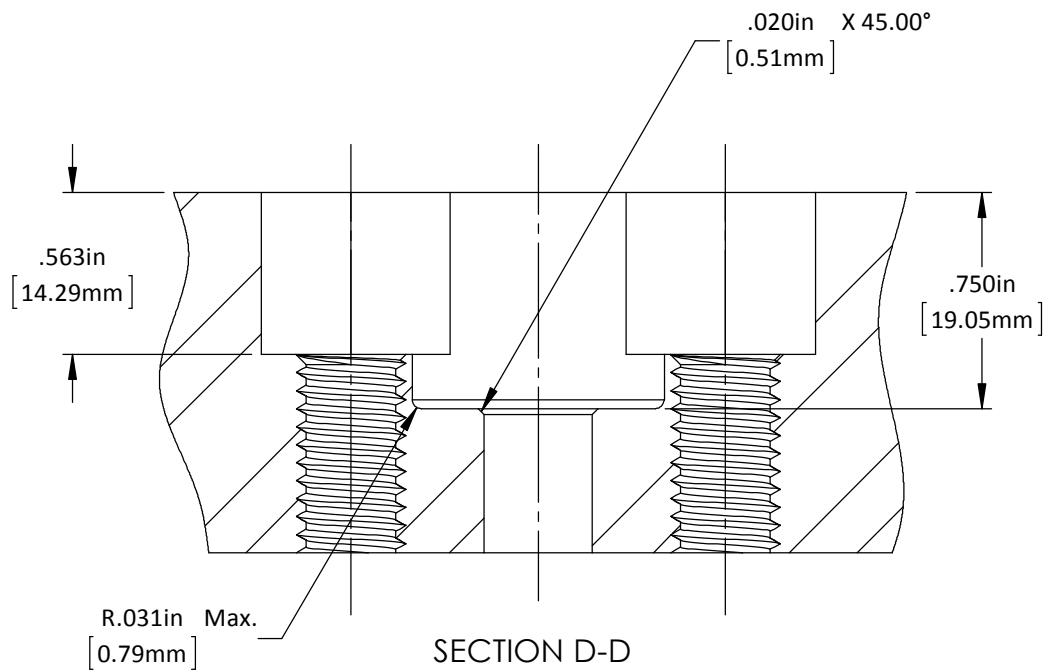
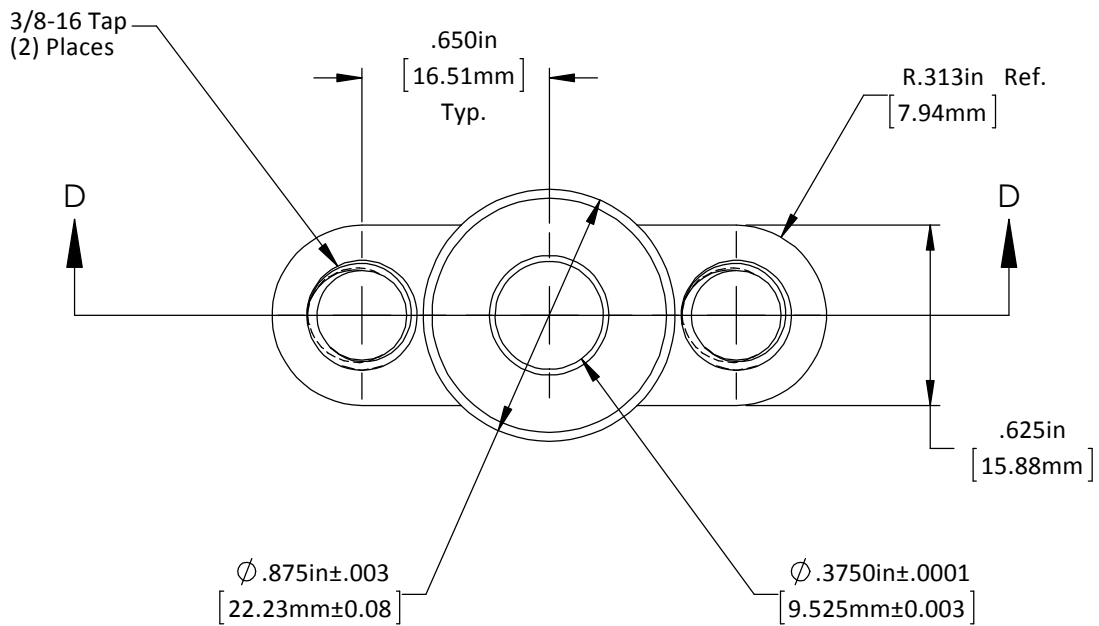

DO NOT SCALE DRAWING

REV 2

This product may be covered by one or more patents or patent applications.
See <http://www.standardlifters.com/patents.html> for details.

Pilot-PA-.375-.050-S-R-F-Machining

STANDARD LIFTERS INC