

DO NOT SCALE DRAWING    REV 1

This product may be covered by one or more patents or patent applications.  
 See <http://www.standardlifters.com/patents.html> for details.

**Guide Pin GK120**

**STANDARD LIFTERS INC**

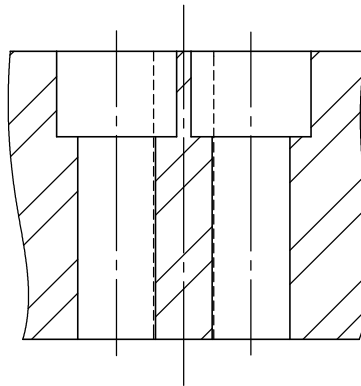
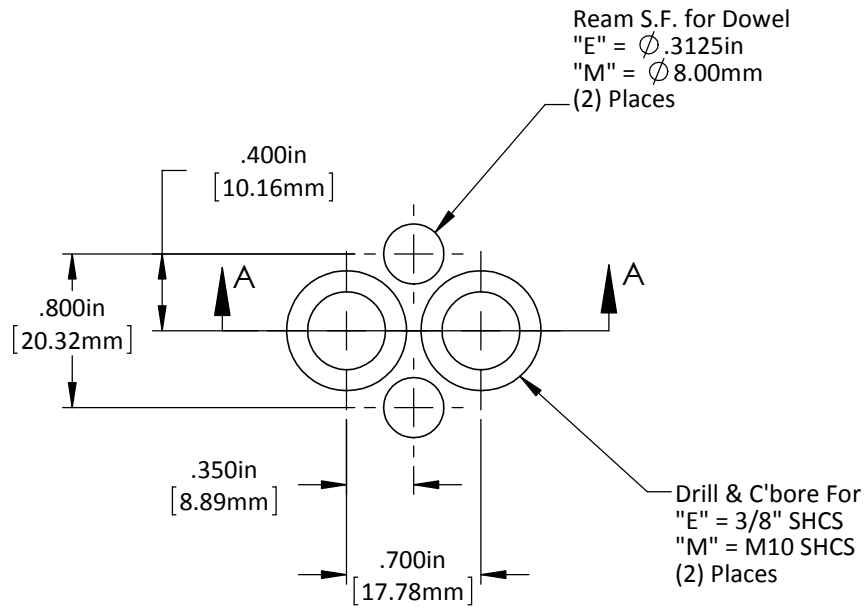

DO NOT SCALE DRAWING	REV 1
This product may be covered by one or more patents or patent applications. See <a href="http://www.standardlifters.com/patents.html">http://www.standardlifters.com/patents.html</a> for details.	

**Guide Pin GK120-Machining**  
**STANDARD LIFTERS INC**