

DO NOT SCALE DRAWING REV 1
 This product may be covered by one or more patents or patent applications.
 See <http://www.standardlifters.com/patents.html> for details.

Base-GK105-D2
STANDARD LIFTERS INC

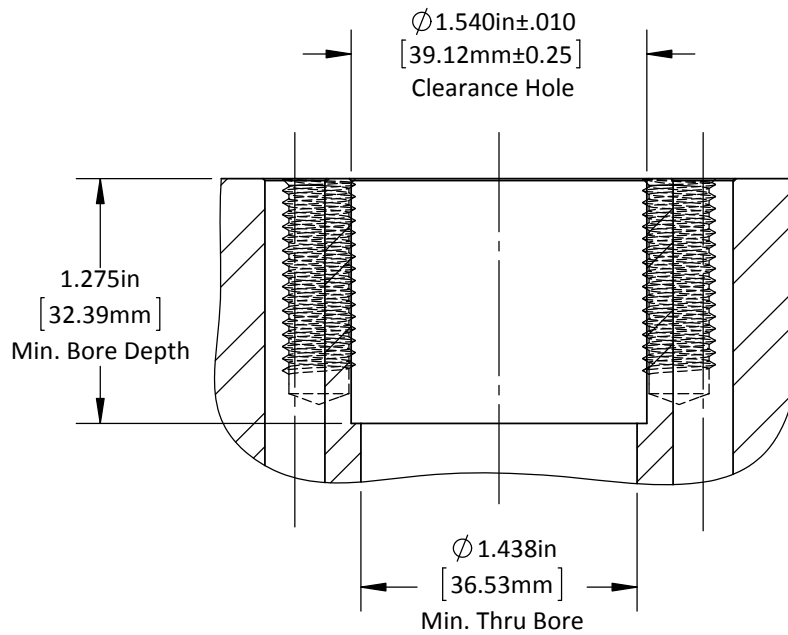
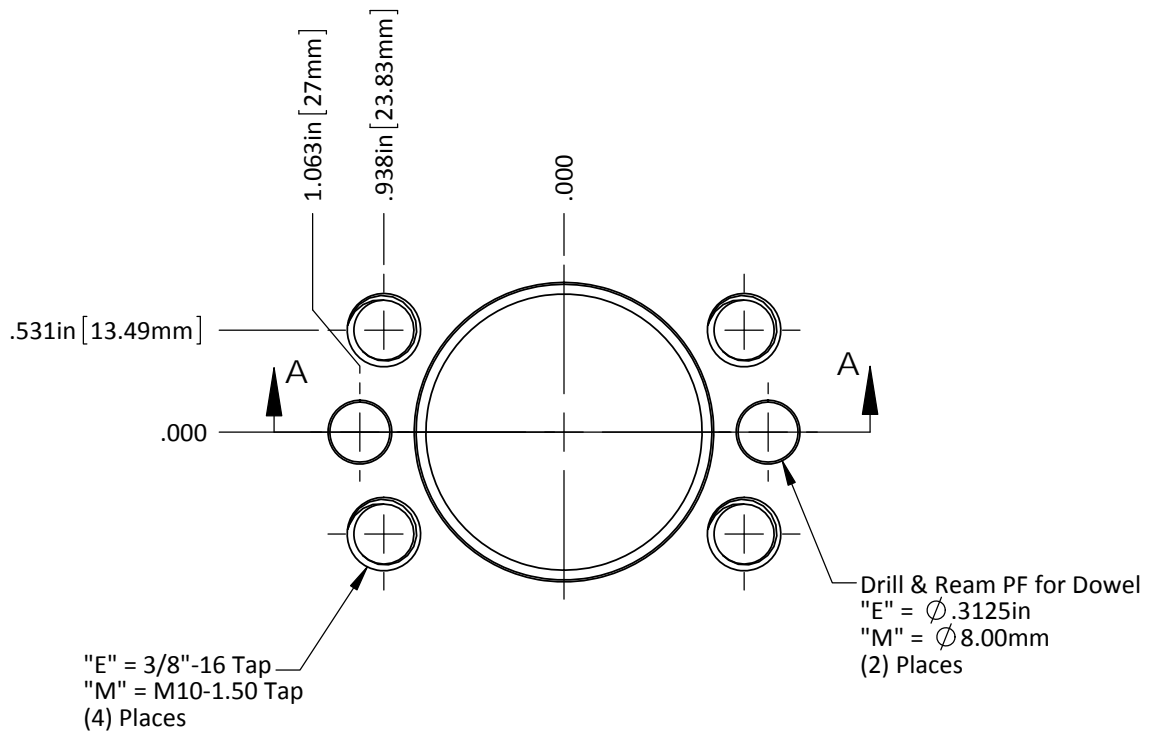

DO NOT SCALE DRAWING

REV 2

This product may be covered by one or more patents or
 patent applications.
 See <http://www.standardlifters.com/patents.html> for details.

GK105-D2-Base-Machining

STANDARD LIFTERS INC